

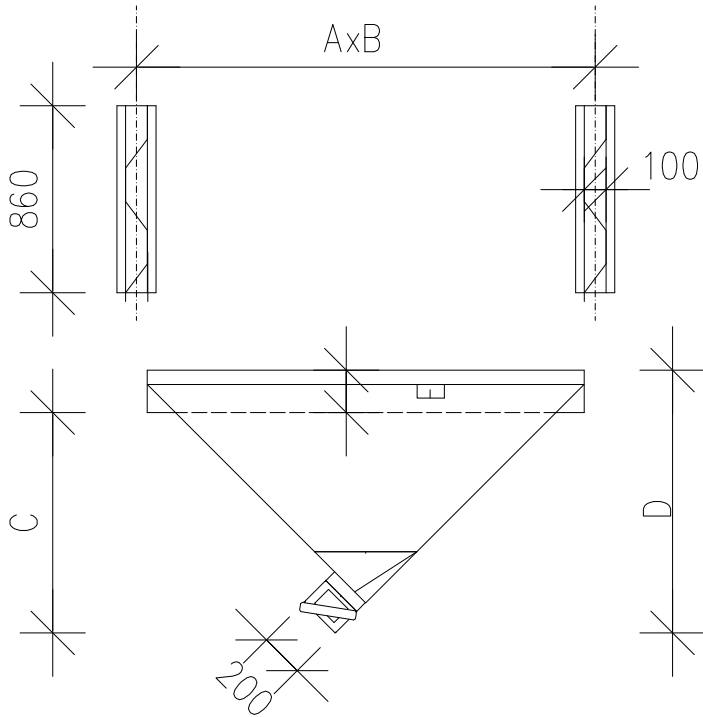

Square Silos



A	B	C	D	E		Silo bottom m ³	Silo / Layer m ³
2110	2110	1075	1235	195	160	1,6	3,8
2110	2600	1315	1475	195	160	2,4	4,7
2600	2600	1300	1495	195		3,0	5,8
2600	3110	1555	1750	195		3,7	6,9
3110	3110	1555	1750	195		5,1	8,3

160 Height of old silo bottoms

Silo alternatives

3 x 3



3,3 x 3,3 m

3 x 2,5



3,3 x 2,8 m

2,5 x 2,5



2,8 x 2,8 m

2 x 2



2,4 x 2,4 m

2 x 2,5



2,8 x 2,4 m

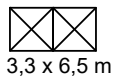

3,3 x 6,5 m

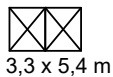

3,3 x 5,4 m



2,8 x 6,5 m

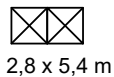

2,8 x 5,4 m

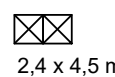

2,4 x 4,5 m

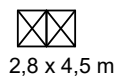

2,8 x 4,5 m

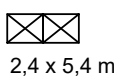

2,4 x 5,4 m

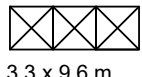

3,3 x 9,6 m

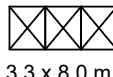

3,3 x 8,0 m

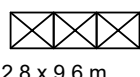

2,8 x 9,6 m

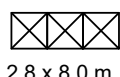

2,8 x 8,0 m

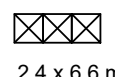

2,4 x 6,6 m



2,8 x 6,6 m

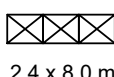

2,4 x 8,0 m

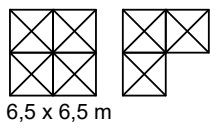

6,5 x 6,5 m

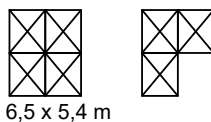

6,5 x 5,4 m

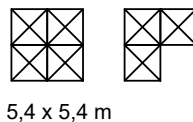

5,4 x 5,4 m

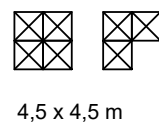

4,5 x 4,5 m

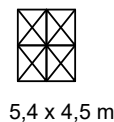

5,4 x 4,5 m

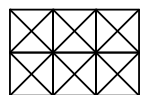

6,5 x 9,6 m

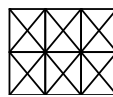

6,5 x 8,0 m

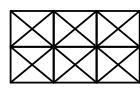

6,5 x 9,6 m

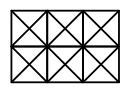

5,4 x 8,0 m

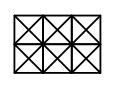

4,5 x 6,6 m

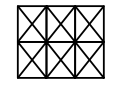

5,4 x 6,6 m

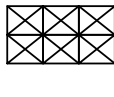

4,5 x 8,0 m